

## Stereo 3.1W Non-inverting Audio Power Amplifier(with DC Volume Control)

### Features

- **Non-Inverting Audio Power Amplifier**
- **Low Operating Current about 9mA (Typical)**
- **Improved Depop Circuitry to Eliminate Turn-On and Turn-Off Transients in Outputs**
- **32-Step Volume Adjustable by DC Voltage with Hysteresis**
- **Output Power at 1% THD+N**
  - 2.4W, at  $V_{DD}=5V$ , BTL Mode,  $R_L=3\Omega$
  - 1.8W, at  $V_{DD}=5V$ , BTL Mode,  $R_L=4\Omega$
- **at 10% THD+N**
  - 3.1W, at  $V_{DD}=5V$ , BTL Mode,  $R_L=3\Omega$
  - 2.6W, at  $V_{DD}=5V$ , BTL Mode,  $R_L=4\Omega$
- **Two Output Modes: BTL and SE Modes Selected by SE/BTL Pin**
- **Low Current Consumption in Shutdown Mode (1mA, Typical)**
- **Short Circuit Protection**
- **Thermal Shutdown Protection and Over Current Protection Circuitry**
- **Power Enhanced Package (DIP-16)**
- **Lead Free and Green Devices Available (RoHS Compliant)**

### General Description

The APA2071 is a monolithic integrated circuit, which provides precise DC volume control, and a stereo bridged audio power amplifiers capable of producing 2.6W (1.8W) into  $4\Omega$  with less than 10% (1.0%) THD+N. The attenuator range of the volume control in APA2071 is from 18dB ( $V_{VOLUME}=0V$ ) to -80dB ( $V_{VOLUME}=3.54V$ ) with 32 steps. The advantage of internal gain setting can be less components and PCB area. Both the depop circuitry and the thermal shutdown protection circuitry are integrated in the APA2071, that reduce pops and clicks noise during power up or shutdown mode operation. It also improves the power off pop noise and protects the chip being destroyed by over temperature and short current failure. To simplify the audio system design, the APA2071 combines a stereo bridge-tied load (BTL) mode for speaker drive and a stereo single-end (SE) mode for headphone drive into a single chip, where both modes are easily switched by the SE/BTL input control pin signal.

### Applications

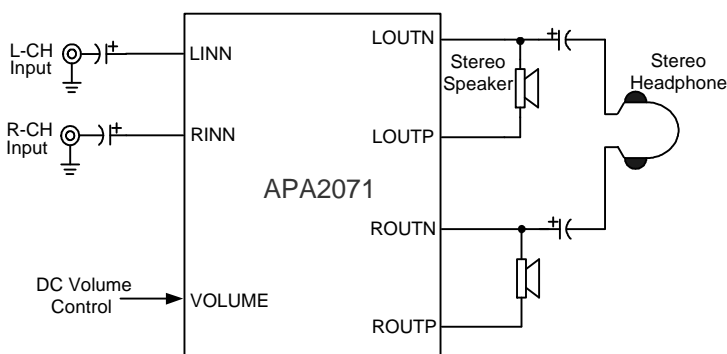

- **Notebook PC**
- **LCD Monitor or TV**

### Simplified Application Circuit

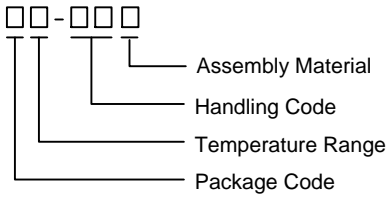

ANPEC reserves the right to make changes to improve reliability or manufacturability without notice, and advise customers to obtain the latest version of relevant information to verify before placing orders.

## Ordering and Marking Information

<p>APA2071 <span style="font-family: monospace;">□□-□□□</span></p>  <p>             Assembly Material              Handling Code              Temperature Range              Package Code         </p>	<p>             Package Code              J : DIP-16              Operating Ambient Temperature Range              I : - 40 to 85 °C              Handling Code              TU : Tube              Assembly Material              L : Lead Free Device G : Halogen and Lead Free Device         </p>
<p>APA2071 J :</p> <div style="border: 1px solid black; padding: 2px; display: inline-block;">  </div>	<p>XXXXX - Date Code</p>

Note : ANPEC lead-free products contain molding compounds/die attach materials and 100% matte tin plate termination finish; which are fully compliant with RoHS. ANPEC lead-free products meet or exceed the lead-free requirements of IPC/JEDEC J-STD-020C for MSL classification at lead-free peak reflow temperature. ANPEC defines “Green” to mean lead-free (RoHS compliant) and halogen free (Br or Cl does not exceed 900ppm by weight in homogeneous material and total of Br and Cl does not exceed 1500ppm by weight).

## Pin Configuration

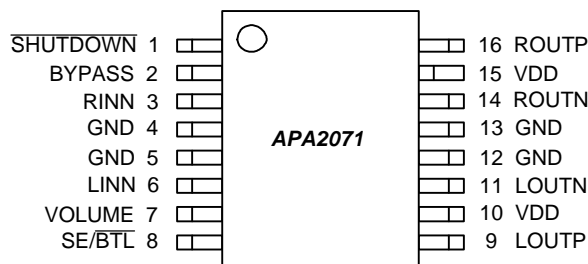

## Absolute Maximum Ratings (Note 1)

Symbol	Parameter	Rating	Unit
$V_{DD}$	Supply Voltage (VDD to GND)	-0.3 to 6	V
	Input Voltage (SE/BTL, SHUTDOWN, VOLUME, RINN, LINN to GND)	-0.3 to $V_{DD} + 0.3$	V
	Output Voltage (LOUTN, LOUTP, ROUTP, ROUTN to GND)	-0.3 to $V_{DD} + 0.3$	V
$T_A$	Operating Ambient Temperature Range	-40 to 85	°C
$T_J$	Maximum Junction Temperature	150	°C
$T_{STG}$	Storage Temperature Range	-65 to +150	°C
$T_{SDR}$	Maximum Lead Soldering Temperature, 10 Seconds	260	°C
$P_D$	Power Dissipation	Internally Limited	W

Note 1: Absolute Maximum Ratings are those values beyond which the life of a device may be impaired. Exposure to absolute maximum rating conditions for extended periods may affect device reliability.

## Thermal Characteristics

Symbol	Parameter	Typical Value	Unit
$\theta_{JA}$	Junction-to-Ambient Resistance in Free Air <sup>(Note 2)</sup>	45	°C/W
$\theta_{JC}$	Junction-to-Case Resistance in Free Air <sup>(Note 3)</sup>	8	°C/W

Note 2:  $\theta_{JA}$  is measured with the component mounted on a high effective thermal conductivity test board in free air.

Note 3: The case temperature is measured at the center of the GND pin on the beside of the DIP-16 package.

**Recommended Operating Conditions** (Note 4)

Symbol	Parameter	Range	Unit	
V <sub>DD</sub>	Supply Voltage	3.3 ~ 5.5	V	
V <sub>IH</sub>	High Level Threshold Voltage	$\overline{\text{SHUTDOWN}}$		0.4V <sub>DD</sub> ~ V <sub>DD</sub>
		SE/ $\overline{\text{BTL}}$		0.8V <sub>DD</sub> ~ V <sub>DD</sub>
V <sub>IL</sub>	Low Level Threshold Voltage	$\overline{\text{SHUTDOWN}}$		0 ~ 1.0
		SE/ $\overline{\text{BTL}}$		0 ~ 1.0
V <sub>CIM</sub>	Common Mode Input Voltage	~ V <sub>DD</sub> -1.0		
T <sub>A</sub>	Ambient Temperature Range	-40 ~ 80	°C	
T <sub>J</sub>	Junction Temperature Range	-40 ~ 125		
R <sub>L</sub>	Speaker Resistance	3 ~	Ω	
R <sub>L</sub>	Headphone Resistance	16 ~		

Note 4 : Refer to the typical application circuit

**Electrical Characteristics**

Unless otherwise specified, these specifications apply over V<sub>DD</sub>=5V, V<sub>GND</sub>=0V and T<sub>A</sub>= -40 ~ 85 °C. Typical values are at T<sub>A</sub>=25°C.

Symbol	Parameter	Test Conditions	APA2071			Unit
			Min.	Typ.	Max.	
I <sub>DD</sub>	Supply Current	V <sub>SE/<math>\overline{\text{BTL}}</math></sub> =0V	-	9	20	mA
		V <sub>SE/<math>\overline{\text{BTL}}</math></sub> =5V	-	4	10	
I <sub>SD</sub>	Shutdown Current	V <sub>SE/<math>\overline{\text{BTL}}</math></sub> =0V, V <sub><math>\overline{\text{SHUTDOWN}}</math></sub> =0V	-	1	-	
T <sub>START-UP</sub>	Start-Up Time from Shutdown	C <sub>BYPASS</sub> =2.2μF	-	1.6	-	s
R <sub>i</sub>	Input Resistance		-	20	-	kΩ
<b>BTL mode. V<sub>DD</sub>=5V, Gain=6dB (unless otherwise noted)</b>						
P <sub>O</sub>	Output Power, f <sub>in</sub> =1kHz	V <sub>DD</sub> =5.5V, THD+N=3%, R <sub>L</sub> =3Ω	-	3.1	-	W
		THD+N=10%, R <sub>L</sub> =3Ω	-	3.1	-	
		THD+N =10%, R <sub>L</sub> =4Ω	-	2.6	-	
		THD+N =10%, R <sub>L</sub> =8Ω	-	1.6	-	
		THD+N =1%, R <sub>L</sub> =3Ω	-	2.4	-	
		THD+N =1%, R <sub>L</sub> =4Ω	-	1.8	-	
		THD+N =0.5%, R <sub>L</sub> =8Ω	1	1.3	-	
THD+N	Total Harmonic Distortion Pulse Noise	P <sub>O</sub> =1.2W, R <sub>L</sub> =4Ω, f <sub>in</sub> =1kHz	-	0.07	-	%
		P <sub>O</sub> =0.9W, R <sub>L</sub> =8Ω, f <sub>in</sub> =1kHz	-	0.08	-	
PSRR	Power Supply Rejection Ratio	V <sub>DD</sub> Ripple=0.1Vrms, R <sub>L</sub> =8Ω, C <sub>BYPASS</sub> =2.2μF, f <sub>in</sub> =217Hz	-	60	-	dB
Crosstalk	Channel Separation	C <sub>BYPASS</sub> =2.2μF, R <sub>L</sub> =8Ω, f <sub>in</sub> =1kHz	-	90	-	dB

## Electrical Characteristics (Cont.)

Unless otherwise specified, these specifications apply over  $V_{DD}=5V$ ,  $V_{GND}=0V$  and  $T_A = -40 \sim 85 \text{ }^\circ\text{C}$ . Typical values are at  $T_A=25^\circ\text{C}$ .

Symbol	Parameter	Test Conditions	APA2071			Unit
			Min.	Typ.	Max.	
<b>BTL mode. <math>V_{DD}=5V</math>, Gain=6dB (unless otherwise noted) (Cont.)</b>						
$V_{OS}$	Output Offset Voltage	$R_L=4\Omega$	-	5	-	mV
S/N	Signal to Noise Ratio	$P_O=1.1W$ , $R_L=8\Omega$ , A_wieghting	-	95	-	dB
<b>SE mode. <math>V_{DD}=5V</math>, Gain=0dB</b>						
$P_o$	Output Power, $f_{in}=1\text{kHz}$	THD+N=10%, $R_L=16\Omega$	-	220	-	mW
		THD+N =10%, $R_L=32\Omega$	-	120	-	
		THD+N =1%, $R_L=16\Omega$	-	160	-	
		THD+N =1%, $R_L=32\Omega$	-	95	-	
THD+N	Total Harmonic Distortion Pulse Noise	$P_O=125\text{mW}$ , $R_L=16\Omega$ , $f_{in}=1\text{kHz}$	-	0.09	-	%
		$P_O=65\text{mW}$ , $R_L=32\Omega$ , $f_{in}=1\text{kHz}$	-	0.09	-	
PSRR	Power Supply Rejection Ratio	$V_{DD}$ Ripple =0.1Vrms, $R_L=32\Omega$ , $C_{BYPASS}=2.2\mu\text{F}$ , $f_{in}=217\text{Hz}$	-	60	-	dB
Crosstalk	Channel Separation	$C_{BYPASS}=2.2\mu\text{F}$ , $R_L=32\Omega$ , $f_{in}=1\text{kHz}$	-	60	-	dB
$V_{OS}$	Output Offset Voltage	$R_L=32\Omega$	-	5	-	mV
S/N	Signal to Noise Ratio	$P_O=75\text{mW}$ , $R_L=32\Omega$ , A_wieghting	-	100	-	dB

## Typical Operating Characteristics

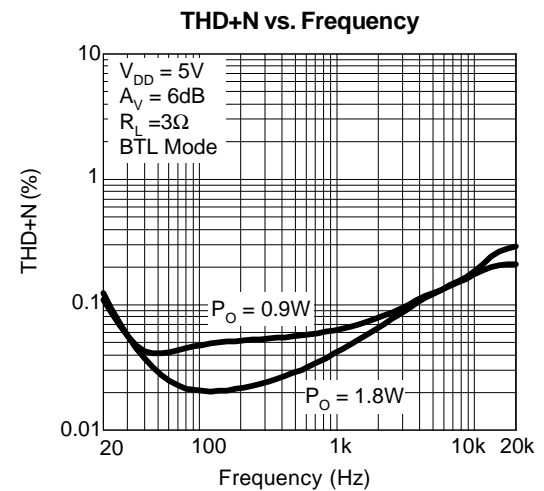
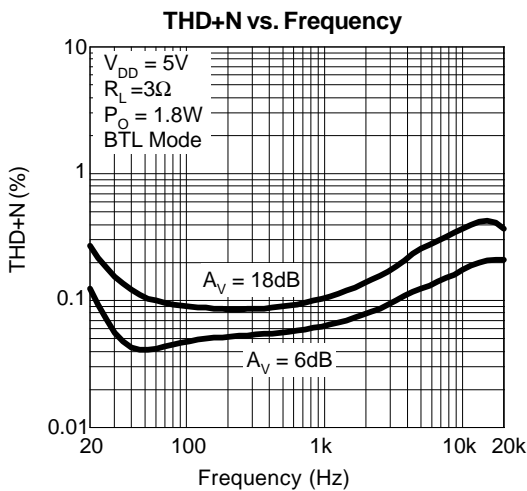
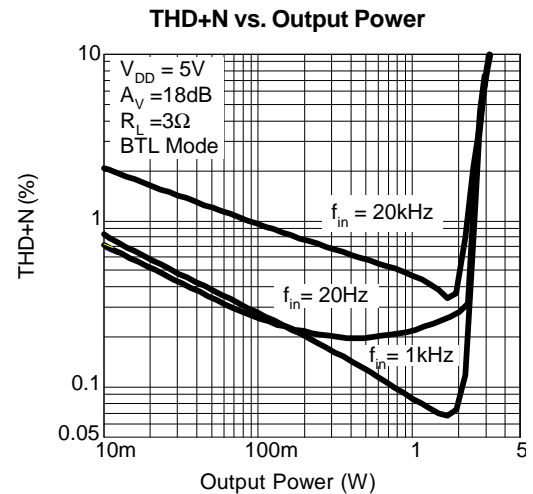
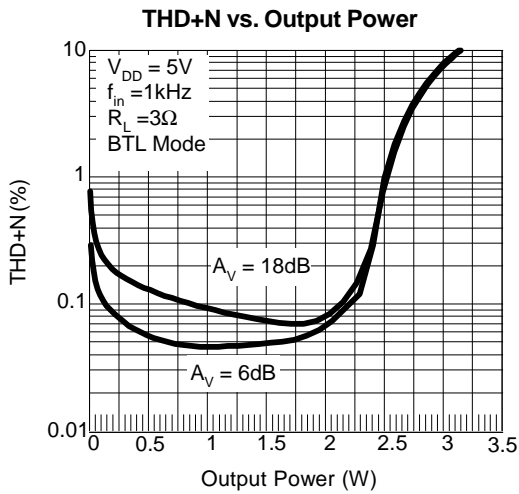
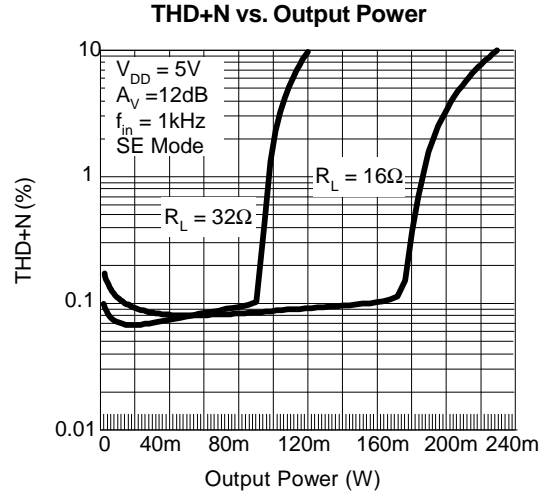
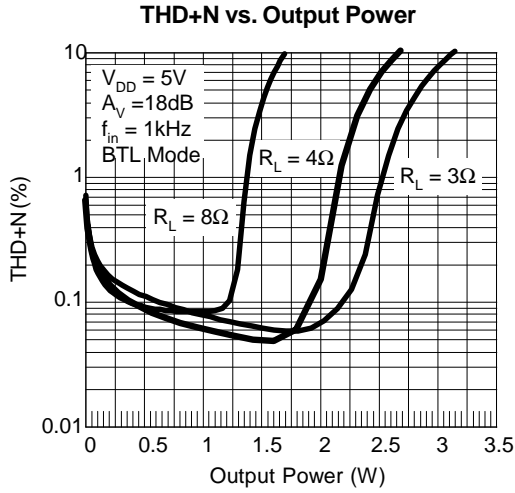

Typical Operating Characteristics (Cont.)

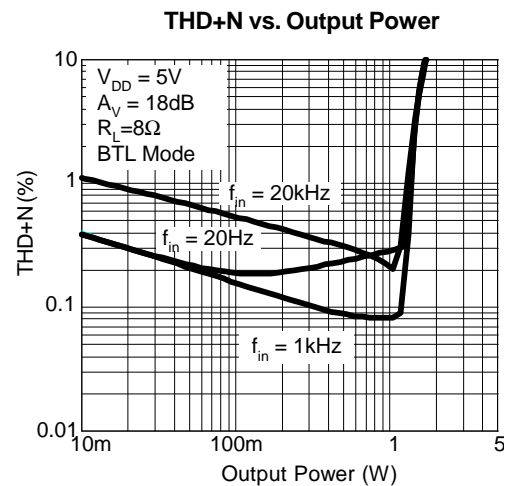
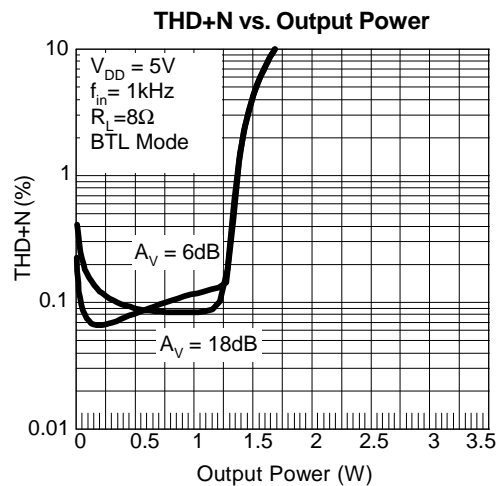
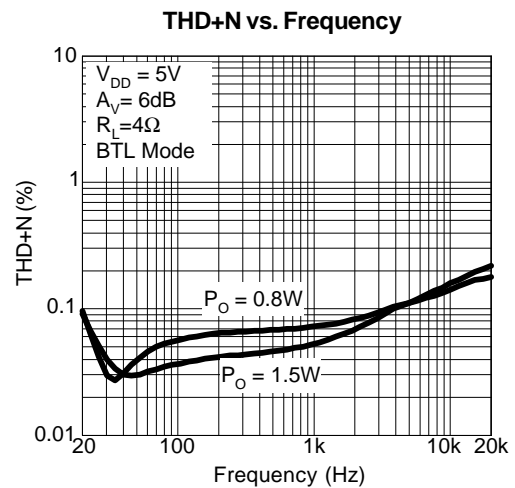
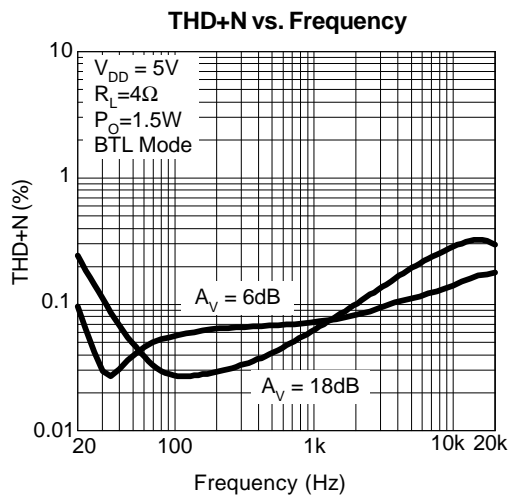
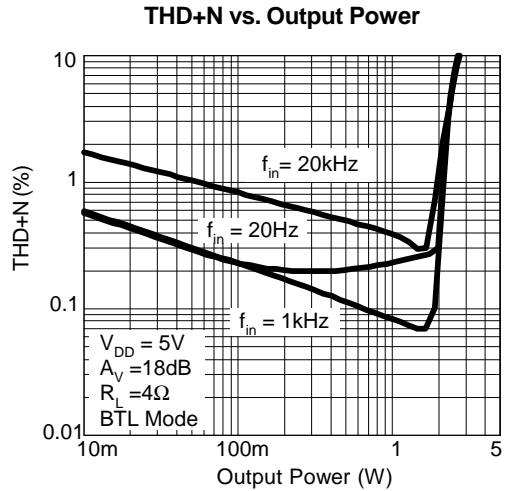
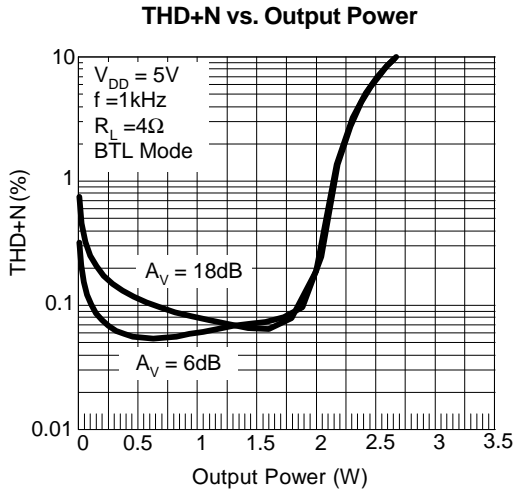

Typical Operating Characteristics (Cont.)

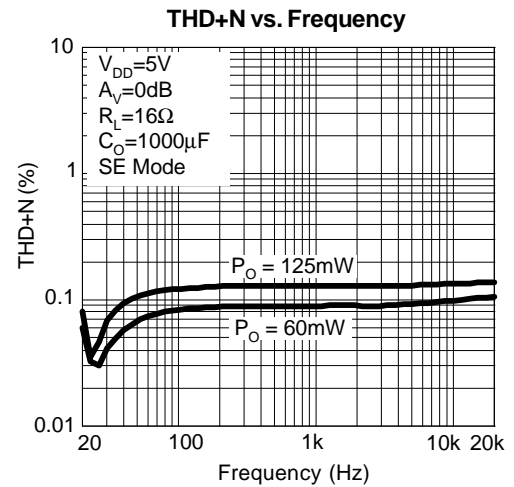
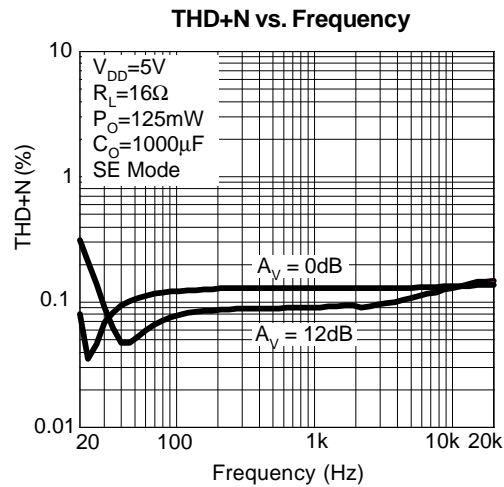
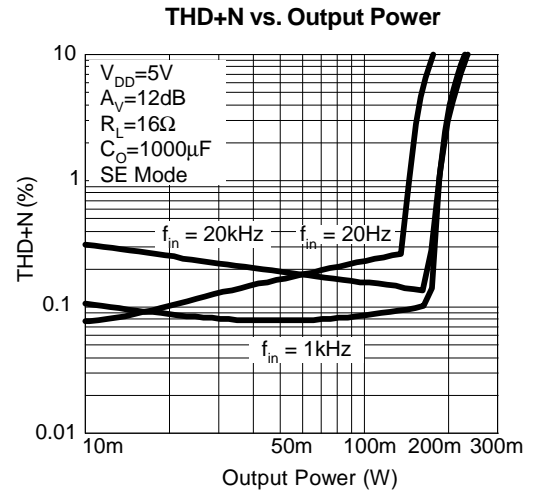
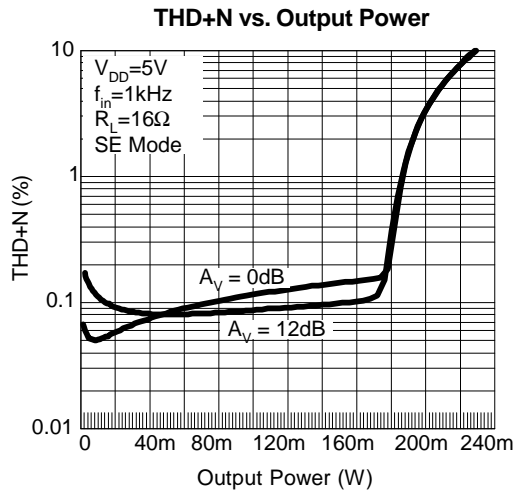
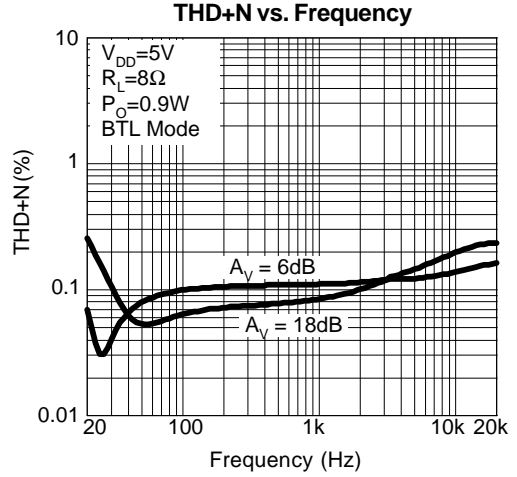
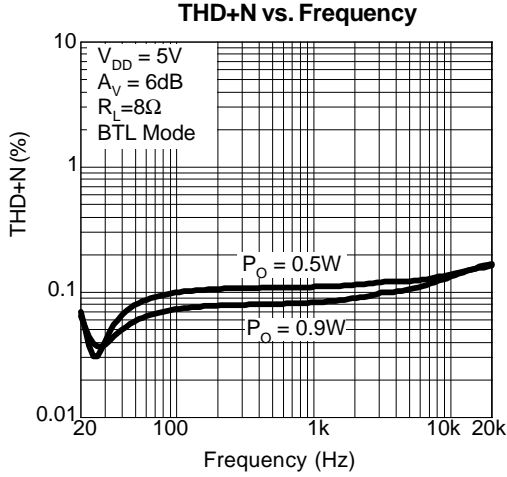

Typical Operating Characteristics (Cont.)

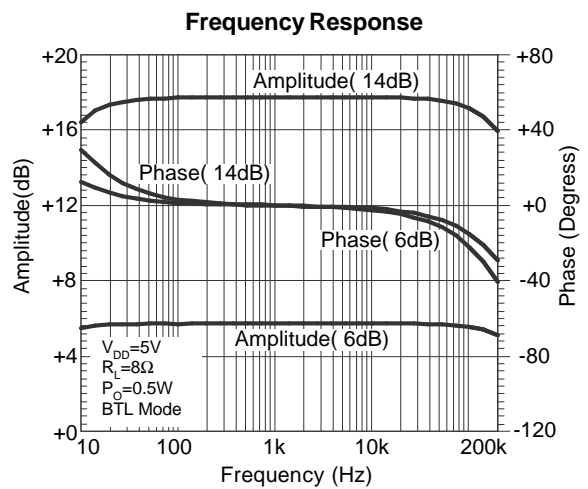
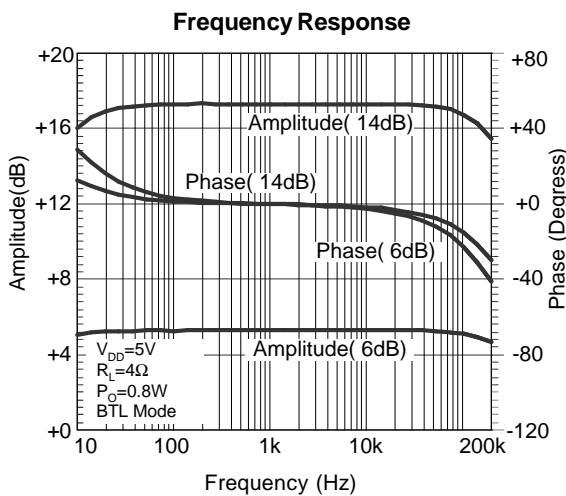
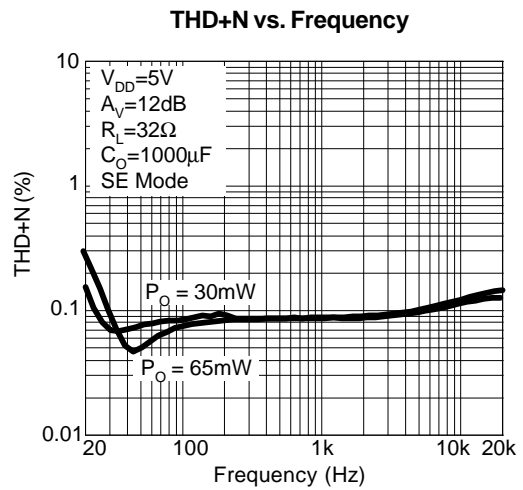
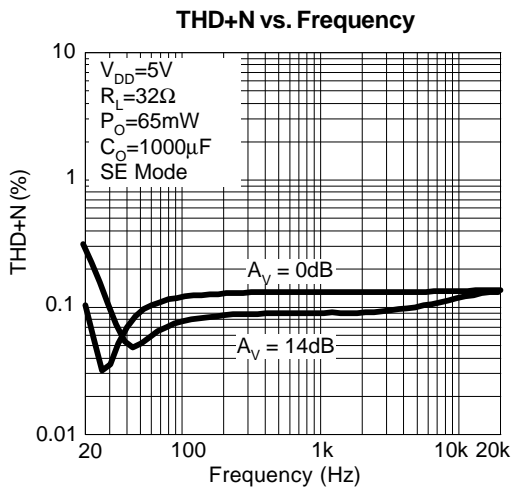
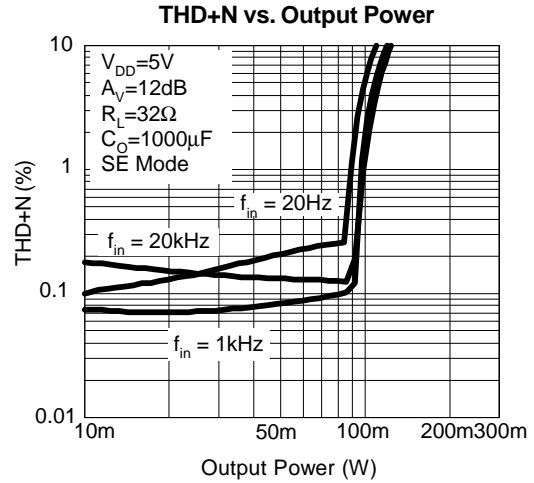
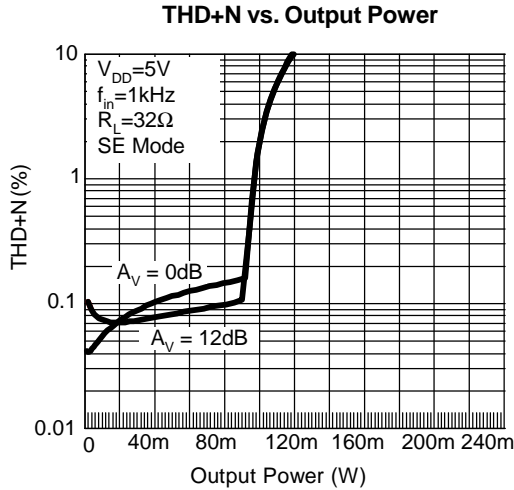



Typical Operating Characteristics (Cont.)

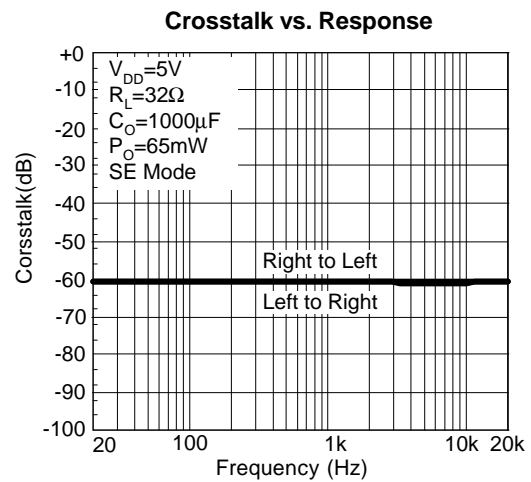
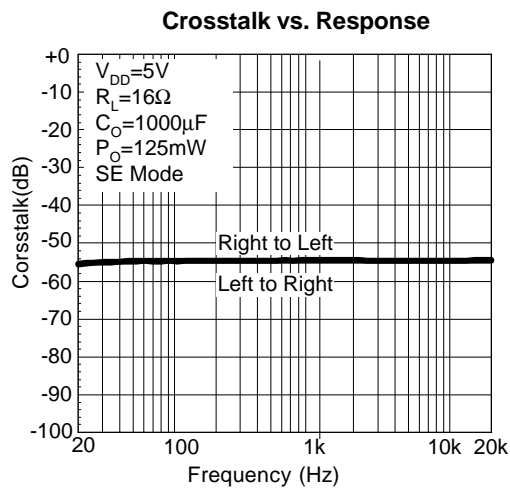
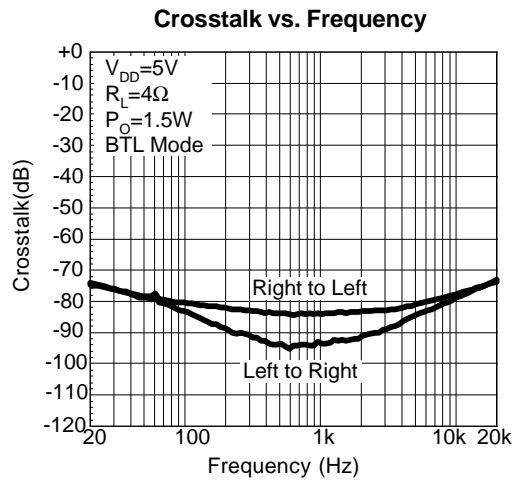
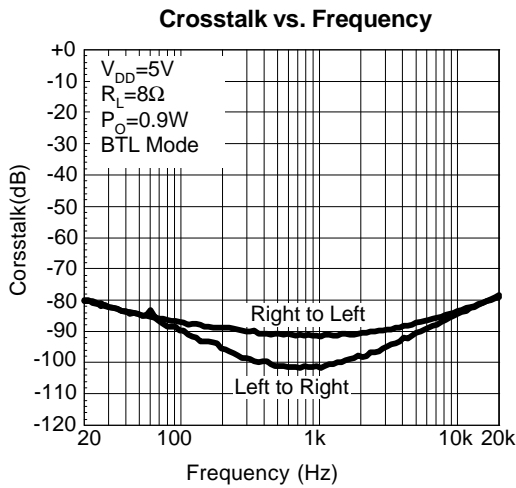
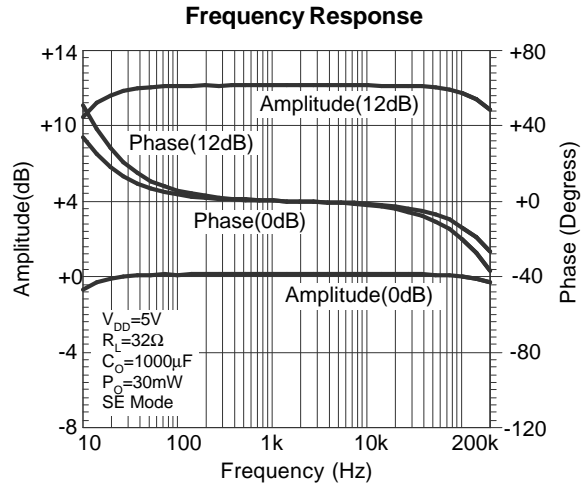
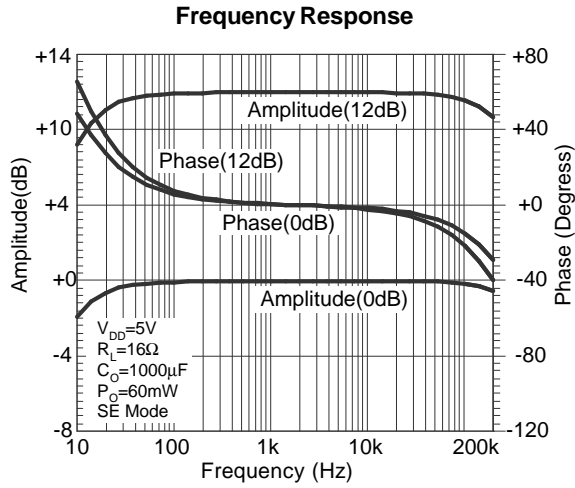

Typical Operating Characteristics (Cont.)

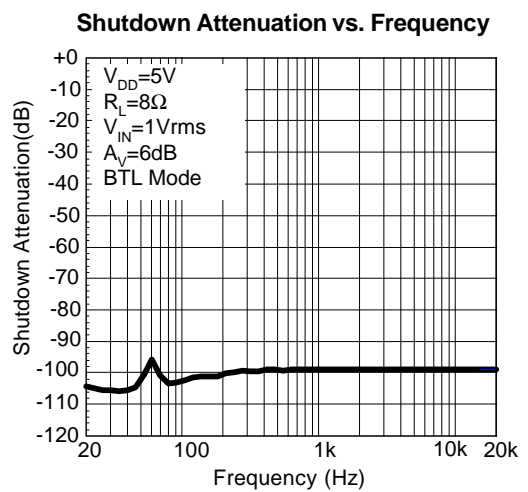
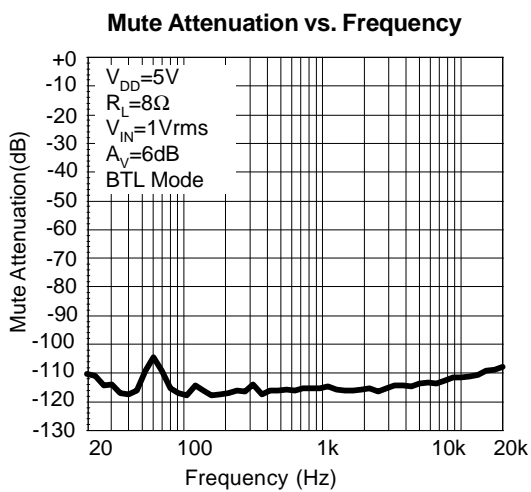
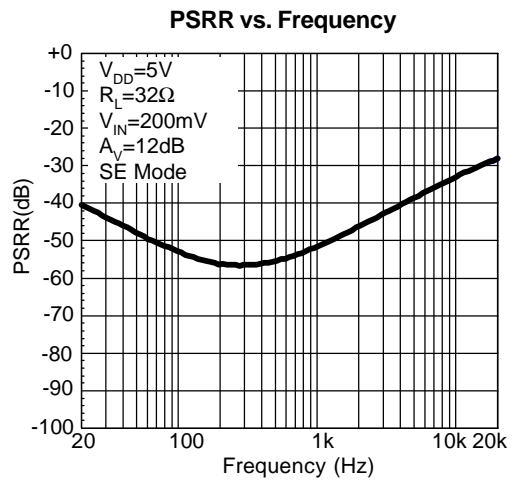
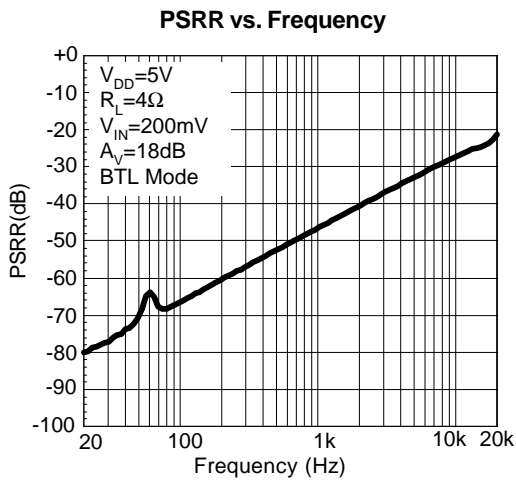
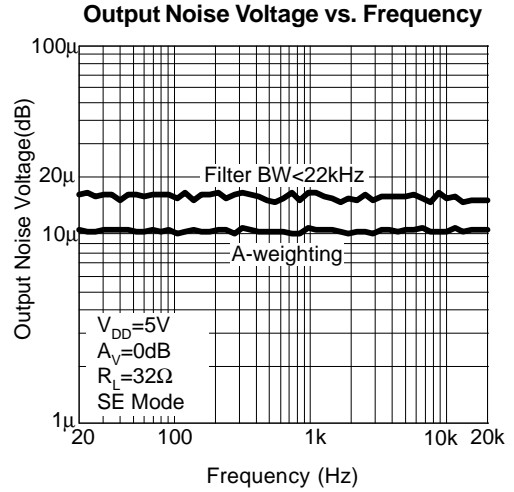
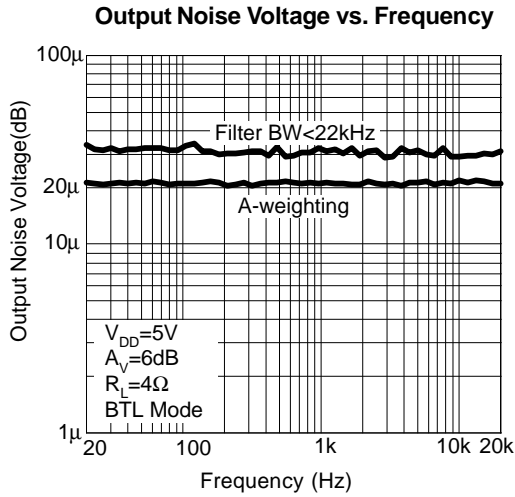

Typical Operating Characteristics (Cont.)

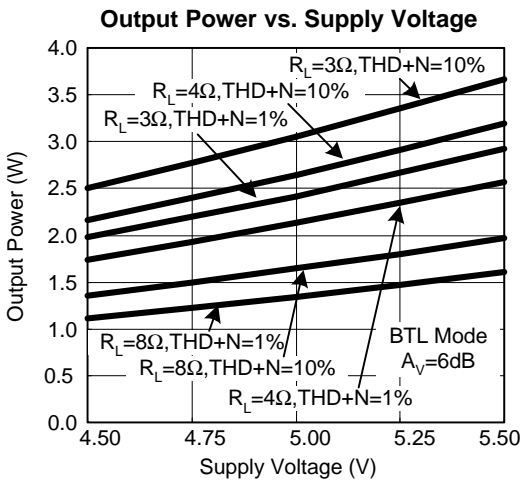
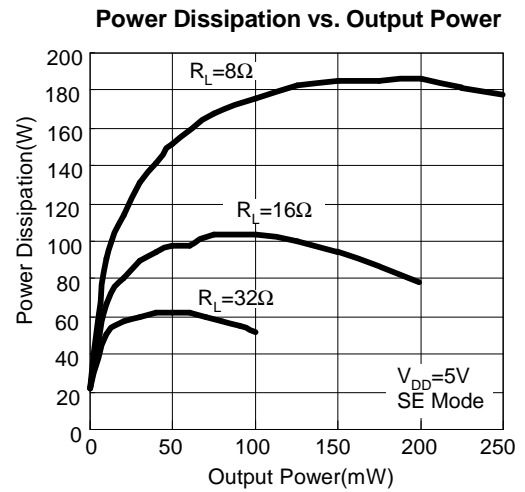
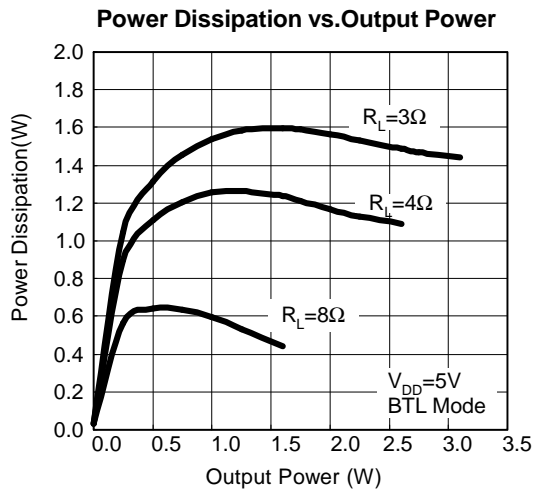
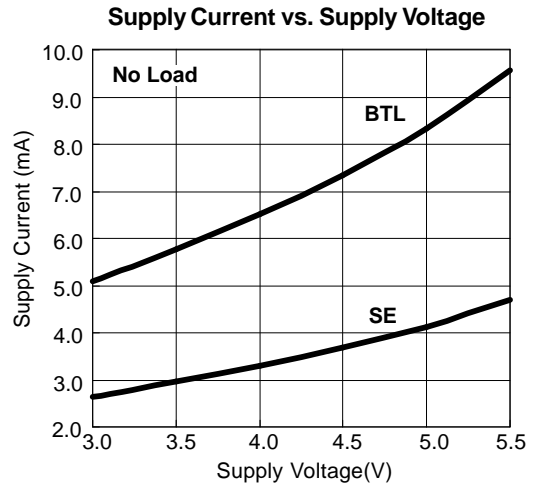
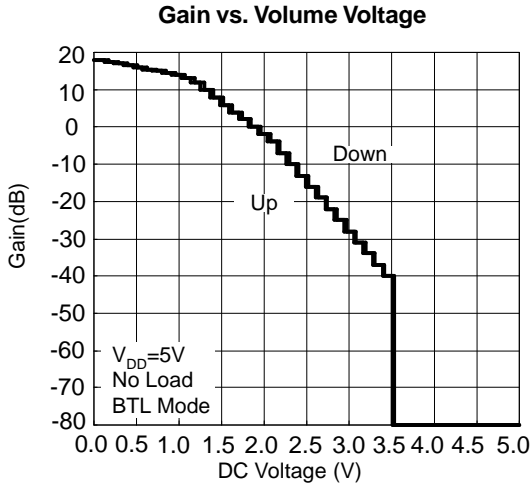

### Pin Description

PIN		FUNCTION
NO.	NAME	
1	$\overline{\text{SHUTDOWN}}$	Shutdown control pin. Pulling low the voltage on this pin shuts off the IC. In shutdown mode, the IC only draws 1 $\mu$ A (typical) of supply current.
2	BYPASS	Bypass capacitor connection pin for the bias voltage generator.
3	RINNN	Right channel input terminal
4,5,12,13	GND	Ground connection. Connect all of the GND pins to ground plane.
6	LINN	Left channel input terminal
7	VOLUME	DC voltage input pin for internal volume gain setting (DC Volume control).
8	$\text{SE}/\overline{\text{BTL}}$	Output mode control input, high for SE output mode and low for BTL mode.
9	LOUTP	Left channel positive output in BTL mode and high impedance in SE mode.
10,15	VDD	Supply voltage input pin. Connect all of the VDD pins to supply voltage.
11	LOUTN	Left channel negative output in BTL mode and SE mode.
14	ROUTN	Right channel negative output in BTL mode and SE mode.
16	ROUTP	Right channel positive output in BTL mode and high impedance in SE mode.

### Block Diagram

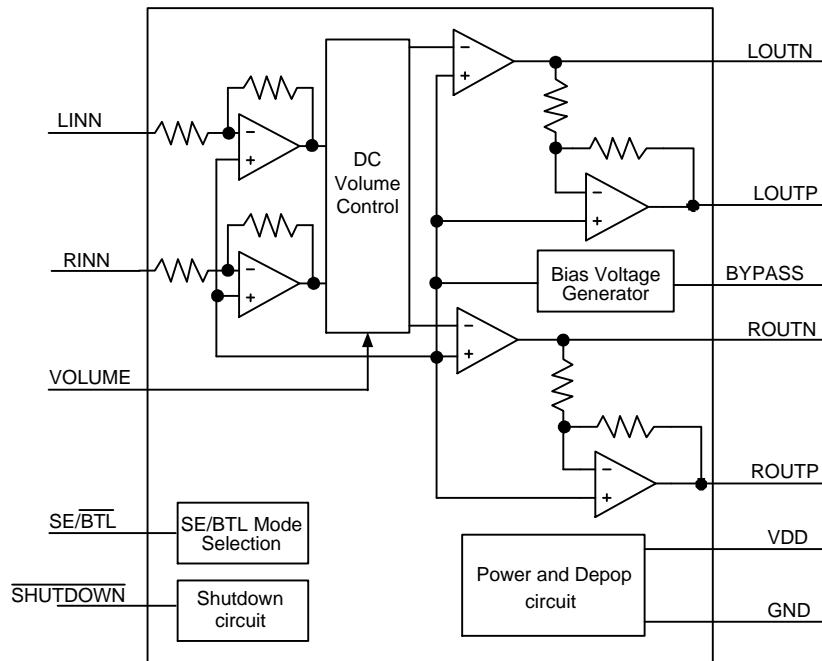

Typical Application Circuit

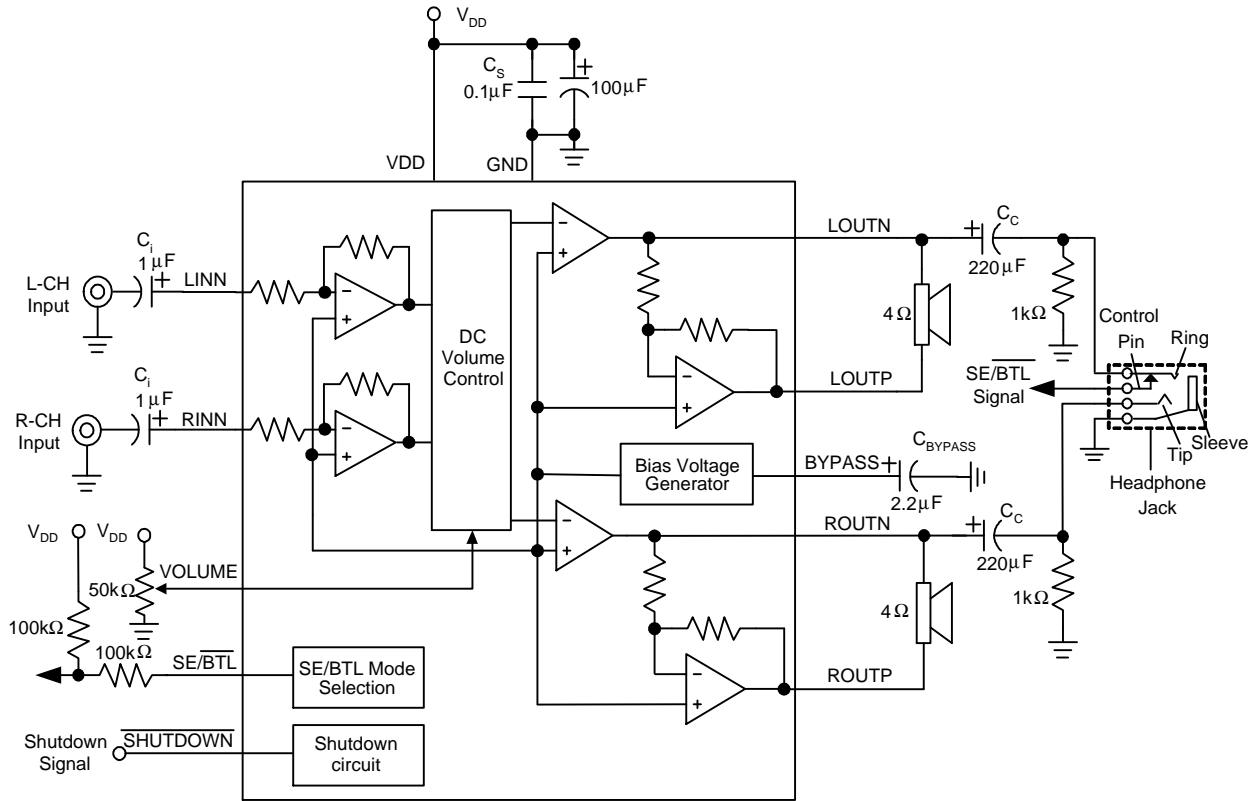

DC Volume Control Table\_BTL Mode

Gain(dB)	Voltage Range (% of V <sub>DD</sub> )			Voltage Range (V <sub>DD</sub> =5V)		
	High(%)	Low(%)	Recommended (%)	High(V)	Low(V)	Recommended (V)
18	2.40	0.00	0.00	0.12	0.00	0.00
17.5	4.60	3.40	4.00	0.23	0.17	0.20
17	6.80	5.60	6.20	0.34	0.28	0.31
16.5	9.20	7.80	8.60	0.46	0.39	0.43
16	11.40	10.20	10.80	0.57	0.51	0.54
15.5	13.80	12.40	13.00	0.69	0.62	0.65
15	16.00	14.60	15.40	0.80	0.73	0.77
14.5	18.20	16.80	17.60	0.91	0.84	0.88
14	20.60	19.20	19.80	1.03	0.96	0.99
13	22.80	21.40	22.00	1.14	1.07	1.10
12	25.00	23.60	24.40	1.25	1.18	1.22
10	27.40	25.80	26.60	1.37	1.29	1.33
8	29.60	28.20	28.80	1.48	1.41	1.44
6	31.80	30.40	31.20	1.59	1.52	1.56
4	34.20	32.60	33.40	1.71	1.63	1.67
2	36.40	34.80	35.60	1.82	1.74	1.78
0	38.60	37.00	37.80	1.93	1.85	1.89
-2	41.00	39.40	40.20	2.05	1.97	2.01
-4	43.20	41.60	42.40	2.16	2.08	2.12
-7	45.60	43.80	44.60	2.28	2.19	2.23
-10	47.80	46.00	47.00	2.39	2.30	2.35
-13	50.00	48.40	49.20	2.50	2.42	2.46
-16	52.40	50.60	51.40	2.62	2.53	2.57
-19	54.60	52.80	53.80	2.73	2.64	2.69
-22	56.80	55.00	56.00	2.84	2.75	2.80
-25	59.20	57.40	58.20	2.96	2.87	2.91
-28	61.40	59.60	60.40	3.07	2.98	3.02
-31	63.60	61.80	62.80	3.18	3.09	3.14
-34	66.00	64.00	65.00	3.30	3.20	3.25
-37	68.20	66.40	67.20	3.41	3.32	3.36
-40	70.40	68.60	69.60	3.52	3.43	3.48
-80	100.00	70.80	100.00	5.00	3.54	5.00

## Function Description

### Bridge-Tied Load (BTL) Operation

The APA2071's output stage of each channel, which consists of one pair of operational amplifiers, provides option for BTL operation shown as figure 1.

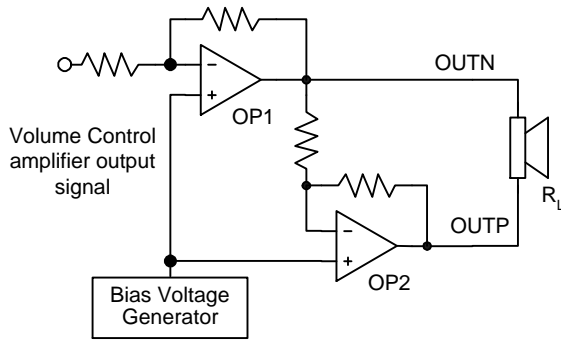

Figure 1: APA2071 Internal Configuration (each channel)

The power amplifier's (OP1) gain is set by internal unity gain and input audio signal comes from internal volume control amplifier while the second amplifier (OP2) is internally fixed in a unity-gain, inverting configuration. Figure 1 shows that the output of OP1 is connected to the input to OP2, which results in the output signals of with both amplifiers with identical in magnitude but out of phase 180°. Consequently, the differential gain for each channel is 2 x (Gain of SE mode).

By driving the load differentially through outputs OUTP and OUTN, an amplifier configuration is commonly referred to as bridged mode is established. BTL mode operation is different from the classical single-ended (SE) amplifier configuration where one side of its load is connected to ground.

A BTL amplifier design has a few distinct advantages over the SE configuration, as it provides differential drive to the load, thus doubles the output swing for a specified supply voltage.

Four times the output power is possible as compared with a SE amplifier under the same conditions. A BTL configuration, such as the one used in APA2071, also creates a second advantage over SE amplifiers. Since the differential outputs, ROUTP, ROUTN, LOUTP, and LOUTN, are biased at half-supply, DC voltage doesn't have to exist across the load. This eliminates the need for an output coupling capacitor which is required in a single supply, SE configuration.

### Single-Ended (SE) Operation

To consider the single-supply SE configuration shown in Typical Application Circuit, a coupling capacitor is required to block the DC offset voltage from reaching the load. These capacitors can be quite large (approximately 33μF to 1000μF) so they tend to be expensive, occupy valuable PCB area, and have the additional drawback of limiting low-frequency performance of the system (refer to the Output Coupling Capacitor). The rules described still hold with the addition of the following relationship:

$$\frac{1}{C_{\text{bypass}} \times 130\text{k}\Omega} \leq \frac{1}{2R_{\text{Ci}}} \ll \frac{1}{2R_{\text{L}}C_{\text{c}}} \quad (1)$$

### SE/BTL Mode Selection Function

Easy switch between BTL and SE modes is one of its most important costs saving features for the APA2071. This feature eliminates the requirement for an additional headphone amplifier in applications where internal stereo speakers are driven in BTL mode but external headphone or speakers must be accommodated.

Inside of the APA2071, two separated amplifiers drive OUTP and OUTN (See Figure 1). The SE/BTL input controls the operation of the follower amplifier that drives LOUTP and ROUTN.

- When SE/BTL keeps low, the OP2 turns on and the APA2071 is in the BTL mode.
- When SE/BTL keeps high, the OP2 is in a high output impedance state, which configures the APA2071 as SE driver from OUTP. I<sub>DD</sub> is reduced by approximately one-half in SE mode.

Control of the SE/BTL input can be a logic-level TTL source or a resistor divider network or the stereo headphone jack with switch pin as shown in Typical Application Circuit.

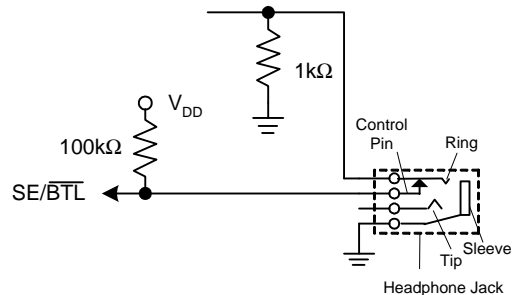

Figure 2: SE/BTL Input Selection by Phonejack Plug

## Function Description (Cont.)

### SE/BTL Mode Selection Function (Cont.)

In Figure 2, input SE/ $\overline{\text{BTL}}$  operates as below:

When the phonejack plug is inserted, the 1k $\Omega$  resistor is disconnected and the SE/ $\overline{\text{BTL}}$  input is pulled high to enable the SE mode. Meanwhile, the OUTN amplifier is shut down which turns the speaker to be mute. The OUTP amplifier then drives through the output capacitor into the headphone jack. When there is no headphone plugged into the system, the contact pin of the headphone jack is connected from the signal pin, and the voltage divider is set up by resistors 100k $\Omega$  and 1k $\Omega$ . Resistor 1k $\Omega$  then is pulled low the SE/ $\overline{\text{BTL}}$  pin, enabling the BTL function.

### DC Volume Control Function

The APA2071 has an internal stereo volume control whose setting is the function of the DC voltage applied to the VOLUME input pin. The APA2071 volume control consists of 32 steps that are individually selected by a variable DC voltage level on the VOLUME control pin. The range of the steps, controlled by the DC voltage, are from 18dB to -80dB. Each gain step corresponds to a specific input voltage range, as shown in table. To minimize the effect of noise on the volume control pin, which can affect the selected gain level, hysteresis and clock delay are implemented. The amount of hysteresis corresponds to half of the step width, as shown in volume control graph.

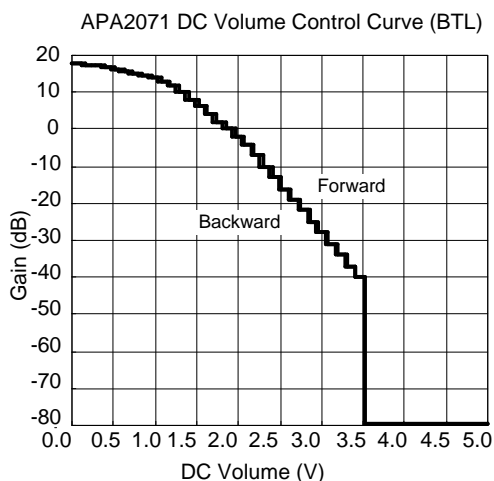

Figure 3: Gain setting vs. VOLUME pin voltage

For the highest accuracy, the voltage shown in the 'recommended voltage' column of the table is used to select a desired gain. This recommended voltage is exactly half-way between the two nearest transitions. The gain levels are 32 steps from 18dB to -40dB in BTL mode, and the last step at -80dB as mute mode.

### Shutdown Function

In order to reduce power consumption while not in using, the APA2071 contains a shutdown pin to externally turn off the amplifier bias circuitry. This shutdown feature turns the amplifier off when a logic low is placed on the  $\overline{\text{SHUTDOWN}}$  pin. The trigger point between a logic high and logic low level is typically 2.0V. It would be better to switch between ground and the supply  $V_{DD}$  to provide maximum device performance.

By switching the  $\overline{\text{SHUTDOWN}}$  pin to low, the amplifier enters a low-current state,  $I_{DD} < 1\mu\text{A}$ . APA2071 is in shutdown mode. On normal operation,  $\overline{\text{SHUTDOWN}}$  pin is pulled to high level to keep the IC out of the shutdown mode. The  $\overline{\text{SHUTDOWN}}$  pin should be tied to a definite voltage to avoid unwanted state changes.

### Thermal Protection

The thermal protection circuit limits the junction temperature of the APA2071. When the junction temperature exceeds  $T_j = +150^\circ\text{C}$ , a thermal sensor turns off the amplifier, allowing the devices to cool. The thermal sensor allows the amplifier to start-up after the junction temperature down about  $125^\circ\text{C}$ . The thermal protection is designed with a  $25^\circ\text{C}$  hysteresis to lower the average  $T_j$  during continuous thermal overload conditions, which is increasing lifetime of the IC.

### Over-Current Protection

The APA2071 monitors the output current. When the current exceeds the current-limit threshold, the APA2071 turns off the output to prevent the IC from damages in over-current or short-circuit condition. When the over-current occurs in power amplifier, the output buffer's current will be foldbacked to a low setting level, and it will release when over-current situation is no long existence. On the contrary, if the over-current period is long enough and the IC's junction temperature reaches the thermal protection threshold, the IC will enter thermal protection mode.



## Application Information

### Input Capacitor (C<sub>i</sub>)

In the typical application, an input capacitor, C<sub>i</sub>, is required to allow the amplifier to bias the input signal to the proper DC level for optimum operation. In this case, C<sub>i</sub> and the fixed input impedance R<sub>i</sub> form a high-pass filter with the corner frequency is determined in the following equation:

$$f_{C(\text{highpass})} = \frac{1}{2\pi R_i C_i} \quad (2)$$

The value of C<sub>i</sub> must be considered carefully because it directly affects the low frequency performance of the circuit. Consider the example where R<sub>i</sub> is 20kΩ and the specification calls for a flat bass response down to 40Hz. The equation is reconfigured below :

$$C_i = \frac{1}{2\pi R_i f_c} \quad (3)$$

Consider the variation of input resistance (R<sub>i</sub>), the value of C<sub>i</sub> should be 0.2μF. Therefore, it's better to choose a value in the range from 0.22μF to 1.0μF. A further consideration for this capacitor is the leakage path from the input source through the input network (R<sub>i</sub> + R<sub>f</sub>, C<sub>i</sub>) to the load.

This leakage current creates a DC offset voltage at the input to the amplifier that reduces useful headroom, especially in high gain applications. For this reason, a low-leakage tantalum or ceramic capacitor is the best choice. When polarized capacitors are used, the positive side of the capacitors should face the amplifiers' inputs in most applications because the DC level of the amplifiers' inputs are held at V<sub>DD</sub>/2. Please note that it is important to confirm the capacitor polarity in the application.

### Effective Bypass Capacitor (C<sub>BYPASS</sub>)

A power amplifier, proper supply bypassing, is critical for low noise performance and high power supply rejection. The capacitor location on the BYPASS pin should be as close to the device as possible. The effect of a larger supply bypass capacitor is to improve PSRR due to increased half-supply stability. Two critical criteria of bypass capacitor (C<sub>BYPASS</sub>): 1<sup>st</sup>, it depends upon desired PSRR requirements and click-and-pop performance; 2<sup>nd</sup>, the leakage current of C<sub>BYPASS</sub> will induce the voltage drop of V<sub>BYPASS</sub> (voltage of BYPASS pin), and if the V<sub>BYPASS</sub> is less

than 0.485V<sub>DD</sub>, the APA2071 will enter mute condition. The value of V<sub>BYPASS</sub> can be calculated as below:

$$V_{BYPASS} = 0.5V_{DD} - I_{Leakage} \times 130k\Omega \quad (4)$$

Where

I<sub>Leakage</sub> = Leakage current of C<sub>BYPASS</sub>

Therefore, it is recommended that C<sub>BYPASS</sub>'s leakage current should be no more than 0.5μA for properly work of the APA2071.

To avoid start-up pop noise, the bypass voltage should rise slower than the input bias voltage and the relationship shown in equation should be maintained.

$$\frac{1}{(C_{BYPASS} \times 130k\Omega)} \ll \frac{1}{C_i \times 20k\Omega} \quad (5)$$

The capacitor is fed from a 130kΩ resistor inside of the amplifier and the 20kΩ is the fixed input resistance. Bypass capacitor, C<sub>BYPASS</sub>, values of 2.2μF to 10μF ceramic or tantalum low-ESR capacitors are recommended for the best THD+N and noise performance. The bypass capacitance also affects the start-up time. It is determined in the following equation:

$$T_{start\ up} = 5X(C_{BYPASS} \times 130k\Omega) \quad (6)$$

### Output Coupling Capacitor (C<sub>c</sub>)

In the typical single-supply SE configuration, an output coupling capacitor (C<sub>c</sub>) is required to block the DC bias at the output of the amplifier thus preventing DC currents in the load. As with the input coupling capacitor, the output coupling capacitor and impedance of the load form a high-pass filter governed by the equation.

$$F_{C(\text{highpass})} = \frac{1}{2\pi R_L C_C} \quad (7)$$

For example, a 330μF capacitor with an 8Ω speaker would attenuate low frequencies below 60.6Hz. The main disadvantage, from a performance standpoint, is the load

## Application Information (Cont.)

### Output Coupling Capacitor ( $C_c$ ) (Cont.)

impedance is typically small, which drives the low-frequency corner higher degrading the bass response. Large values of  $C_c$  are required to pass low frequencies into the load.

### Power Supply Decoupling Capacitor ( $C_s$ )

The APA2071 is a high-performance CMOS audio amplifier that requires adequate power supply decoupling to ensure the output total harmonic distortion (THD+N) is as low as possible. Power supply decoupling also prevents the oscillations caused by long lead length between the amplifier and the speaker. The optimum decoupling is achieved by using two different type capacitors that target on different types of noise on the power supply leads. For higher frequency transients, spikes, or digital hash on the line, a good low equivalent-series-resistance (ESR) ceramic capacitor, typically 0.1 $\mu$ F, is placed as close as possible to the device  $V_{DD}$  lead works best. For filtering lower-frequency noise signals, it is recommended to place a large aluminum electrolytic capacitor of 10 $\mu$ F or greater near the audio power amplifier

### Optimizing Depop Circuitry

Circuitry has been included in the APA2071 to minimize the amount of popping noise at power-up and when coming out of shutdown mode. Popping occurs whenever a voltage step is applied to the speaker. In order to eliminate clicks and pops, all capacitors must be fully discharged before turn-on. Rapid on/off switching of the device or the shutdown function will cause the click and pop circuitry.

The value of  $C_i$  will also affect turn-on pops (Refer to Effective Bypass Capacitance). The bypass voltage ramp up should be slower than input bias voltage. Although the bypass pin current source cannot be modified, the size of  $C_{BYPASS}$  can be changed to alter the device turn-on time and the amount of clicks and pops. By increasing the value of  $C_{BYPASS}$ , turn-on pop can be reduced. However, the tradeoff for using a larger bypass capacitor is to increase the turn-on time for this device. There is a linear relationship between the size of  $C_{BYPASS}$  and the turn-on time. In a SE configuration, the output coupling capacitor ( $C_c$ ), is of particular concern.

This capacitor discharges through the internal 10k $\Omega$  resistors. Depending on the size of  $C_c$ , the time constant can be relatively large. To reduce transients in SE mode, an external 1k $\Omega$  resistor can be placed in parallel with the internal 10k $\Omega$  resistor. The tradeoff for using this resistor is an increase in quiescent current. In the most cases, choosing a small value of  $C_i$  in the range of 0.33 $\mu$ F to 1 $\mu$ F,  $C_{BYPASS}$  being equal to 4.7 $\mu$ F and an external 1k $\Omega$  resistor should be placed in parallel with the internal 10k $\Omega$  resistor should produce a virtually clickless and popless turn-on.

A high gain amplifier intensifies the problem as the small delta in voltage is multiplied by the gain, so it is advantageous to use low-gain configurations.

### BTL Amplifier Efficiency

An easy-to-use equation to calculate efficiency starts out as being equal to the ratio of power from the power supply to the power delivered to the load.

The following equations are the basis for calculating amplifier efficiency.

$$\text{Efficiency} = \frac{P_o}{P_{SUP}} \quad (8)$$

Where

$$P_o = \frac{V_{O,RMS}^2}{R_L} = \frac{V_p^2}{2R_L}$$

$$V_{O,RMS} = \frac{V_p}{\sqrt{2}} \quad (9)$$

$$P_{SUP} = V_{DD} \times I_{DD,AVG} = V_{DD} \times \frac{2V_p}{\pi R_L} \quad (10)$$

Efficiency of a BTL configuration :

$$\frac{P_o}{P_{SUP}} = \frac{\frac{V_p^2}{2R_L}}{V_{DD} \times \frac{2V_p}{\pi R_L}} = \frac{\pi V_p}{4V_{DD}} \quad (11)$$

Table 1 is for calculating efficiencies for four different output power levels.

## Application Information (Cont.)

### BTL Amplifier Efficiency (Cont.)

Note that the efficiency of the amplifier is quite low for lower power levels and rises sharply as power to the load is increased resulting in a nearly flat internal power dissipation over the normal operating range. In addition, the internal dissipation at full output power is less than in the half power range. Calculating the efficiency for a specific system is the key to proper power supply design. For a stereo 1W audio system with 8Ω loads and a 5V supply, the maximum draw on the power supply is almost 3W. A final point to remember about linear amplifiers (either SE or BTL) is how to manipulate the terms in the efficiency equation to utmost advantage when possible. Note that in equation,  $V_{DD}$  is in the denominator. This indicates that as  $V_{DD}$  goes down, efficiency goes up. In other words, use the efficiency analysis to choose the correct supply voltage and speaker impedance for the application.

Po (W)	Efficiency (%)	IDD(A)	VPP(V)	PD (W)
0.25	31.25	0.16	2.00	0.55
0.50	47.62	0.21	2.83	0.55
1.00	66.67	0.30	4.00	0.5
1.25	78.13	0.32	4.47	0.35

\*\*High peak voltages cause the THD+N to increase.

Table 1. Efficiency vs. Output Power in 5-V/8Ω BTL Systems

### Power Dissipation

Whether the power amplifier is operated in BTL or SE mode, power dissipation is the major concern. Equation (14) states the maximum power dissipation point for a SE mode operating at a given supply voltage and driving a specified load.

$$\text{SE mode: } P_{D,MAX} = \frac{V_{DD}^2}{2\pi^2 R_L} \quad (12)$$

In BTL mode operation, the output voltage swing is doubled as in SE mode. Thus, the maximum power dissipation point for a BTL mode operating at the same given conditions is 4 times as in SE mode.

$$\text{BTL mode: } P_{D,MAX} = \frac{4V_{DD}^2}{2\pi^2 R_L} \quad (13)$$

Since the APA2071 is a dual channel power amplifier, the maximum internal power dissipation is 2 times that both of equations depend on the mode of operation. Even with this substantial increase in power dissipation, the APA2071 does not require extra heatsink. The power dissipation from equation (14), assuming a 5V-power supply and an 8Ω load, must not be greater than the power dissipation that results from the equation (16):

$$P_{D,MAX} = \frac{T_{J,MAX} - T_A}{\theta_{JA}} \quad (14)$$

For DIP-16 package, the thermal resistance ( $\theta_{JA}$ ) is equal to 45°C/W.

Since the maximum junction temperature ( $T_{J,MAX}$ ) of the APA2071 is 150°C and the ambient temperature ( $T_A$ ) is defined by the power system design, the maximum power dissipation which the IC package is able to handle can be obtained from equation 16.

Once the power dissipation is greater than the maximum limit ( $P_{D,MAX}$ ), either the supply voltage ( $V_{DD}$ ) must be decreased, the load impedance ( $R_L$ ) must be increased or the ambient temperature should be reduced.

### Thermal Consideration

Linear power amplifiers dissipate a significant amount of heat in the package under normal operating conditions. The first consideration to calculate maximum ambient temperatures is the numbers from the Power Dissipation vs. Output Power graphs are per channel values, so the dissipation of the IC heat needs to be doubled for two-channel operation. Given  $\theta_{JA}$ , the maximum allowable junction temperature ( $T_{J,MAX}$ ), and the total internal dissipation ( $P_D$ ), the maximum ambient temperature can be calculated with the following equation. The maximum recommended junction temperature for the APA2071 is 150°C. The internal dissipation figures are taken from the Power Dissipation vs. Output Power graphs.

$$T_{AMax} = T_{JMax} - \theta_{JA} P_D \quad (15)$$

$$150 - 45(0.8*2) = 78^\circ\text{C}$$

## Application Information (Cont.)

### Thermal Consideration (Cont.)

The APA2071 is designed with a thermal shutdown protection that turns the device off when the junction temperature surpasses 150°C to prevent damaging the IC.

### Layout Consideration

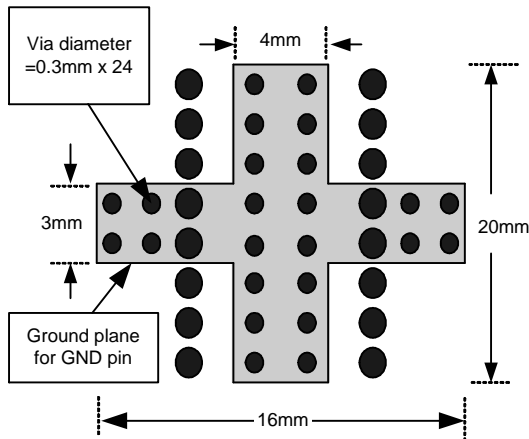
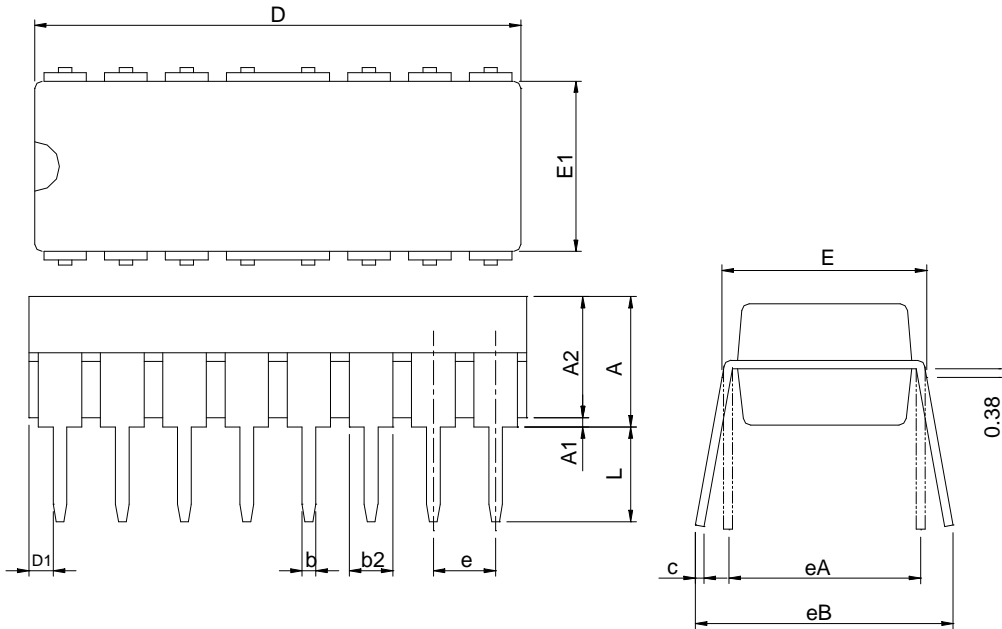

Figure 5: APA 2071 Land Pattern Recommendation

1. All components should be placed close to the APA2071. For example, the input capacitor ( $C_i$ ) should be close to APA2071's input pins to avoid causing noise coupling to APA2071's high impedance inputs; the decoupling capacitor ( $C_s$ ) should be placed by the APA2071's power pin to decouple the power rail noise.
2. The output traces should be short, wide (>50mil), and symmetric.
3. The input trace should be short and symmetric.
4. The power trace width should be greater than 50mil.
5. The APA2071's GND pin should be soldered on ground plane of the PCB.

Package Information

DIP-16



SYMBOL	DIP-16			
	MILLIMETERS		INCHES	
	MIN.	MAX.	MIN.	MAX.
A	-	5.33	-	0.210
A1	0.38	-	0.015	-
A2	2.92	4.95	0.115	0.195
b	0.36	0.56	0.014	0.022
b2	1.14	1.78	0.045	0.070
c	0.20	0.35	0.008	0.014
D	19.81	20.31	0.780	0.800
D1	0.13	-	0.005	-
E	7.62	8.26	0.300	0.325
E1	6.10	7.11	0.240	0.280
e	2.54 BSC		0.100 BSC	
eA	7.62 BSC		0.300 BSC	
eB	-	10.92	-	0.430
L	2.92	3.81	0.115	0.150

Note : 1. Followed from JEDEC MS-001AB  
 2. Dimension D, D1 and E1 do not include mold flash or protrusions. Mold flash or protrusions shall not exceed 10mil.

**Reflow Condition (IR/Convection or VPR Reflow)**

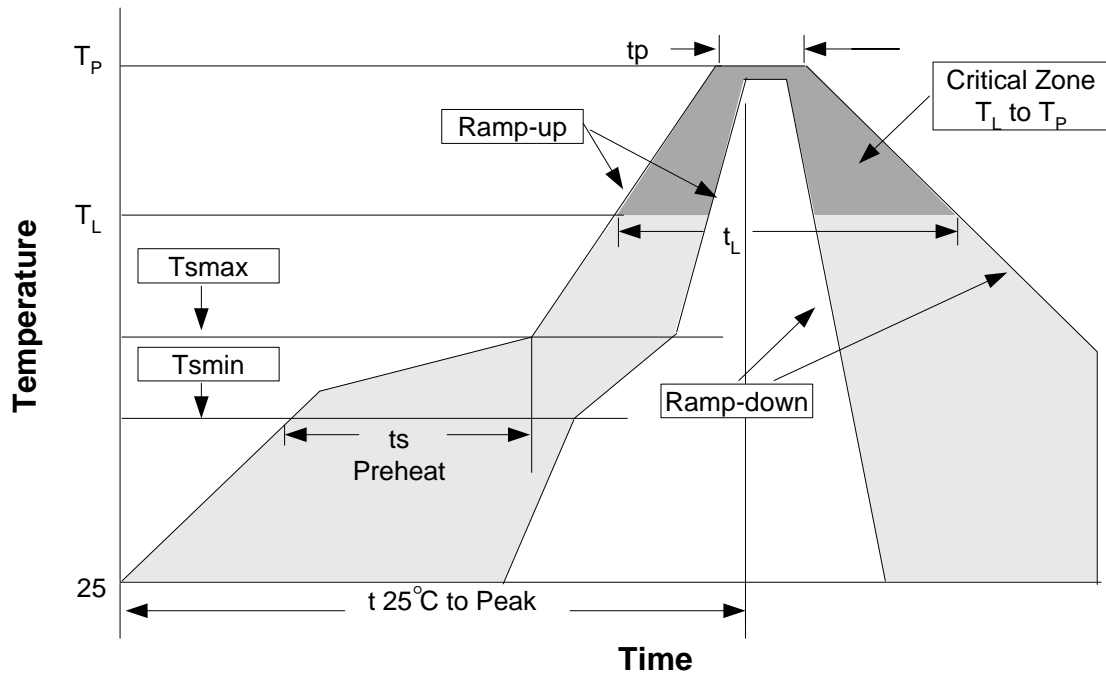

**Reliability Test Program**

Test item	Method	Description
SOLDERABILITY	MIL-STD-883D-2003	245°C, 5 sec
HOLT	MIL-STD-883D-1005.7	1000 Hrs Bias @ 125°C
PCT	JESD-22-B, A102	168 Hrs, 100%RH, 121°C
TST	MIL-STD-883D-1011.9	-65°C~150°C, 200 Cycles
ESD	MIL-STD-883D-3015.7	VHBM > 2KV, VMM > 200V
Latch-Up	JESD 78	10ms, 1 <sub>tr</sub> > 100mA

**Classification Reflow Profiles**

Profile Feature	Sn-Pb Eutectic Assembly	Pb-Free Assembly
Average ramp-up rate (T <sub>L</sub> to T <sub>P</sub> )	3°C/second max.	3°C/second max.
Preheat		
- Temperature Min (T <sub>smin</sub> )	100°C	150°C
- Temperature Max (T <sub>smax</sub> )	150°C	200°C
- Time (min to max) (t <sub>s</sub> )	60-120 seconds	60-180 seconds
Time maintained above:		
- Temperature (T <sub>L</sub> )	183°C	217°C
- Time (t <sub>L</sub> )	60-150 seconds	60-150 seconds
Peak/Classification Temperature (T <sub>p</sub> )	See table 1	See table 2
Time within 5°C of actual Peak Temperature (t <sub>p</sub> )	10-30 seconds	20-40 seconds
Ramp-down Rate	6°C/second max.	6°C/second max.
Time 25°C to Peak Temperature	6 minutes max.	8 minutes max.

Note: All temperatures refer to topside of the package. Measured on the body surface.

**Classification Reflow Profiles (Cont.)**

Table 1. SnPb Eutectic Process – Package Peak Reflow Temperatures

Package Thickness	Volume mm <sup>3</sup> <350	Volume mm <sup>3</sup> ≥350
<2.5 mm	240 +0/-5°C	225 +0/-5°C
≥2.5 mm	225 +0/-5°C	225 +0/-5°C

Table 2. Pb-free Process – Package Classification Reflow Temperatures

Package Thickness	Volume mm <sup>3</sup> <350	Volume mm <sup>3</sup> 350-2000	Volume mm <sup>3</sup> >2000
<1.6 mm	260 +0°C*	260 +0°C*	260 +0°C*
1.6 mm – 2.5 mm	260 +0°C*	250 +0°C*	245 +0°C*
≥2.5 mm	250 +0°C*	245 +0°C*	245 +0°C*

\*Tolerance: The device manufacturer/supplier **shall** assure process compatibility up to and including the stated classification temperature (this means Peak reflow temperature +0°C. For example 260°C+0°C) at the rated MSL level.

**Customer Service**

**Anpec Electronics Corp.**

Head Office :

No.6, Dusing 1st Road, SBIP,  
Hsin-Chu, Taiwan  
Tel : 886-3-5642000  
Fax : 886-3-5642050

Taipei Branch :

2F, No. 11, Lane 218, Sec 2 Jhongsing Rd.,  
Sindian City, Taipei County 23146, Taiwan  
Tel : 886-2-2910-3838  
Fax : 886-2-2917-3838